



Model Pull Type SERIES
Agro Trend Snow Blower

Operator's Manual & Illustrated Parts List
598560

Issued November 2021

OPERATOR'S MANUAL



This symbol means ATTENTION! BECOME ALERT! YOUR SAFETY IS INVOLVED. The message that follows the symbol contains important information about your safety. Carefully read the message. Make sure you fully understand the causes of possible injury or death.

IF THIS MACHINE IS USED BY AN EMPLOYEE, IS LOANED, OR IS RENTED, MAKE SURE THAT THE OPERATOR UNDERSTANDS THE TWO INSTRUCTIONS BELOW.

BEFORE THE OPERATOR STARTS THE ENGINE:

GIVE INSTRUCTIONS TO THE OPERATOR ON SAFE AND CORRECT USE OF THE MACHINE.
MAKE SURE THE OPERATOR READS AND UNDERSTANDS THE OPERATOR'S MANUAL FOR THIS MACHINE.

⚠ WARNING

IMPROPER OPERATION OF THIS MACHINE CAN CAUSE INJURY OR DEATH.

BEFORE STARTING THE ENGINE, DO THE FOLLOWING:

1. READ THE OPERATOR'S MANUAL.
2. READ ALL SAFETY DECALS ON THE MACHINE.
3. CLEAR THE AREA OF OTHER PERSONS.
4. LEARN AND PRACTICE SAFE USE OF MACHINE CONTROLS IN A SAFE AND CLEAR AREA BEFORE YOU OPERATE THIS MACHINE ON A JOB SITE.

It is your responsibility to observe pertinent laws and regulations and to follow manufacturer's instructions on machine operation and maintenance.

See your Authorized Metco Inc. dealer or Metco Inc. for additional operator's manuals, illustrated parts catalogs, and service manuals.

TO THE OWNER

Congratulations on the purchase of your new Metco Inc. Agro Trend Snow Blower. You have selected a top quality machine that is designed and built with pride to ensure you have many years of efficient and reliable service.

Many people have worked on the design, production, and delivery of this Agro Trend Snow Blower. The information in this manual is based on the knowledge, study, and experience through years of specializing in the manufacturing of farm machinery. This manual is designed to provide you with important information regarding safety, maintenance, and machine operation so you can and will get the best possible performance from your Agro Trend Snow Blower.

Even if you are an experienced operator of this or similar equipment, we ask that you read this manual before operating this Agro Trend Snow Blower. The way you operate, adjust, and maintain this unit will have much to do with its successful performance. Any further questions you may have about this product of Metco Inc. should be directed to your local Metco Inc. dealer or to Metco Inc. 1005 Tribe Road West Montrose, ON N0B 2V0, Canada, 1-519-669-2333.

SPECIFICATIONS AND DESIGN ARE SUBJECT TO CHANGE WITHOUT NOTICE

Metco Inc. is continually making product improvements. In doing so, we reserve the right to make changes and/or add improvements to our products without obligation for the equipment previously sold.

Modifications to this Agro Trend Snow Blower may affect the performance, function, and safety of its operation. Therefore, no modifications are to be made without the written permission of Metco Inc. Any modification made without the written permission of Metco Inc. shall void the warranty of this product.

In the interest of continued safe operation of this Agro Trend Snow Blower, pay particular attention to the safety alert symbol(s) throughout this manual.

Metco Inc. International STATEMENT OF PRODUCT LIABILITY

Metco Inc. recognizes its responsibility to provide customers with a safe and efficient product. Metco Inc., attempts to design and manufacture its products in accordance with all accepted engineering practices effective at the date of design. This statement should not be interpreted to mean that our products will protect against the user's own carelessness or failure to follow common safety practices nor will Metco Inc., be liable for any such act. In addition, Metco Inc., assumes no liability for any altered product or any modified product by users or anyone other than an authorized dealer.

IMPORTANT WARRANTY INFORMATION

The warranty for this Agro Trend Snow Blower appears on page 6 of this manual. In order to establish proper warranty registration, the Warranty Registration must be completed and returned to the factory. Failure to comply with this requirement will result in invalidating the warranty!

LIMITATIONS OF THIS MANUAL

This manual contains operating instructions for your FARM UTILITY 3000 SERIES Agro Trend Snow Blower only. Any mention of other machinery in this manual other than the FARM UTILITY 3000 SERIES Agro Trend Snow Blower is for reference only. This manual does not replace nor is it to be used for any machinery that may be attached to or used in conjunction with the FARM UTILITY 3000 SERIES Agro Trend Snow Blower.

PARTS & SERVICE

As the purchaser of your new Blower, it is very important to consider the following factors:

A. Original Quality

B. Availability of Service Parts

C. Availability of Adequate Service Facilities

Metco Inc. has an excellent dealership network ready to answer any questions you may have about your Blower. Parts for your machine may be ordered through our dealers. When placing a parts order, please have the **model** and **serial number** ready. This will allow the dealer to fill your order as quickly as possible.

For your convenience, we have provided this space for you to record your model number, serial number, and the date of purchase, as well as your dealers name and address.



SERIAL NO.

MODEL NO.

TABLE OF CONTENTS

TO THE OWNER	1
SPECIFICATIONS AND DESIGN ARE SUBJECT TO CHANGE WITHOUT NOTICE	1
Metco Inc. STATEMENT OF PRODUCT LIABILITY	1
IMPORTANT WARRANTY INFORMATION	1
LIMITATIONS OF THIS MANUAL	1
PARTS & SERVICE	2
TABLE OF CONTENTS	3-5
LIMITED WARRANTY	6
SAFETY FIRST	7
NOTICES OF DANGER, WARNING, AND CAUTION	7
<u>Safety Instructions</u>	8
GENERAL	8
BEFORE OPERATING	9
DURING OPERATION	9
MAINTENANCE SAFETY	9
HYDRAULIC SAFETY	10
TRANSPORTATION SAFETY	10
STORAGE SAFETY	10
TIRE SAFETY	11
ASSEMBLY SAFETY	11

TABLE OF CONTENTS	
<u>NAME</u>	<u>PAGE</u>
~~~~~OPERATOR'S INSTRUCTIONS: SNOW BLOWER~~~~~	13
SAFETY PRECAUTIONS	14
PRE-SALE SERVICE, SETUP, OPERATION, & POST-SALE SERVICE	15
INSTALLATION INSTRUCTIONS	16
INSTALLATION INSTRUCTIONS	17
~~~~~ILLUSTRATED PARTS LIST: SNOW BLOWER~~~~~	19
BLOWER ASSEMBLY	20
BLOWER ASSEMBLY (CONTINUED)	22
HOOD TURNER ASSEMBLY	24
PROCEDURE TO MOUNT THE HYDRAULIC TURNER	25
HYDRAULIC TURNER ASSEMBLY	26
P.T.O. ASSEMBLY (EG SHAFTS)	27

WARRANTY POLICY

Warranty Coverage

Warranty covers all defects in workmanship or materials on your Agro Trend Mfg. equipment under normal use.

Warranty Period

The warranty coverage runs for 12 months from the date of purchase. The warranty applies only to the original owner and is not transferable to another party. The dealer must perform pre-delivery inspection prior to delivery or warranty shall be void.

How To Obtain

Customer will return his unit to his local dealer. If the dealer agrees with warranty, then he must notify Agro Trend Mfg. and receive pre-authorization. The dealer will then send the parts and proof of purchase within 21 days of authorization to Agro Trend Mfg. prepaid for inspection and final approval.

Not Covered By This Warranty

Agro Trend Mfg. will not assume any expense or liability for repairs made outside our plant without consent. We are not responsible for damage to any associated equipment or product and will not be liable for loss of profit or other special damages including personal injury.

The obligation of this warranty is in lieu of all other warranties, expressed or implied. Damages caused by normal wear and tear, misuse, abuse, neglect, accident or improper maintenance are not covered by this warranty.

Agro Trend Mfg. reserves the right to make changes in design and improvements upon its products without imposing any obligation upon itself to install the same upon its existing products, or products in the process of manufacture.

Terms & Conditions

Standard

Net 15 and 30 days from date of invoiced and subject to prior credit approval and arrangements. Interest at the rate of 2% per month will be charged on past due accounts.

Conditions

All goods are F.O.B. West Montrose Ontario

Returned Goods

No merchandise is to be returned without written authorization from Agro Trend Mfg. Returned goods with written authorization must be pre-paid and will be subject to a minimum 20% restocking charge.

01/26/2001

OFFICE:

1005 Tribe Road, West Montrose, ON Canada, 519-669-2333

SAFETY FIRST

SAFETY INSTRUCTIONS

“A careful operator is the best insurance against an accident.” Quote from the National Safety Council.

Most accidents can be prevented if the operator:

1. Fully understands how the machine functions.
2. Can anticipate situations which may produce problems.
3. Can make necessary corrections before problems develop.

**THIS SYMBOL MEANS ATTENTION!
BECOME ALERT!
YOUR SAFETY IS INVOLVED!**



- Universal Safety Alert Symbol

The American Society of Agricultural Engineers has adopted the Universal Safety Alert Symbol as a way to identify areas of potential danger if the equipment is not operated correctly. Please be alert whenever you see this symbol in the manuals or on your Blower.

Metco Inc. strives to make our equipment as safe as possible. The Metco Inc. UTILITY 3000 SERIES Agro Trend Snow Blower conforms to applicable safety standards at the time of manufacturing. A safety conscious equipment operator makes an effective accident-prevention program complete

Safety features and instructions for the Blower are detailed in the Safety Guidelines section of this Operator's Manual. It is the responsibility of the owner to ensure that all operators read and understand the manual before they are allowed to operate the Snow Blower. (Occupational Safety and Health Administration (OSHA) regulations 1928.57).

NOTICES OF DANGER, WARNING, AND CAUTION

Signal Words: Note the use of signal words **DANGER**, **WARNING**, and **CAUTION** on the Blower and in this manual. The appropriate signal word for each has been selected using the following guidelines:

⚠ DANGER

Indicates a hazardous situation which, if not avoided, will result in death or serious injury.

⚠ WARNING

Indicates a hazardous situation which, if not avoided, could result in death or serious injury.

⚠ CAUTION

Indicates a potentially hazardous situation which, if not avoided, could result in minor or moderate injury.

NOTICE

NOTICE is used to address practices not related to physical injury.

SAFETY INSTRUCTIONS

Safety instructions (or equivalent) signs indicate specific safety-related instructions or procedures.

Note: Contains additional information important to a procedure and will be found within the regular text body of this manual.

GENERAL

SAFETY INSTRUCTIONS

Most work related accidents are caused by failure to observe basic safety rules or precautions. An accident can often be avoided by recognizing potentially hazardous situations before an accident occurs. As you operate and maintain the Snow Blower you must be alert to potential hazards. You should also have the necessary training, skills, and tools to perform any assembly procedure.

Improper operation and/or maintenance of this unit could cause a dangerous situation that results in injury or death.

Do not use this unit until you read and understand the information contained in this manual. Do not use this equipment for anything other than its intended purpose.



Safety precautions and warnings are provided in this manual and on the unit. If these hazard warnings are not heeded, bodily injury or death could occur to you or to other persons.

Metco Inc. cannot anticipate every possible circumstance that might involve a potential hazard. The warnings in this manual and on the product are, therefore, not all-inclusive. If a method of operation not specifically recommended by us is used, you must satisfy yourself that it is safe for you and for others. You should also ensure that the unit will not be damaged or be made unsafe by the methods that you choose.

The information, specifications, and illustrations in this manual are based on the information that was available at the time this material was written and can change at any time.

Safety Alert Symbols



death.

This is the safety alert symbol. It is used to alert you to potential personal injury hazards. Obey all safety messages that follow this symbol to avoid possible injury or death.

This manual contains DANGERS, WARNINGS, CAUTIONS, NOTICES, SAFETY INSTRUCTIONS, and NOTES which must be followed to prevent the possibility of improper service, damage to the equipment, personal injury, or death. The following key words call the readers attention to potential hazards.

Hazards are identified by the "Safety Alert Symbol" and followed by a signal word such as "DANGER", "WARNING", or "CAUTION".

**SAFETY
INSTRUCTIONS**

Remember:
"The Best Operator is a Safe Operator"

⚠ CAUTION





Read and understand the operator's manual and all the safety decals before operating the Blower. Review all safety instructions with all operators annually.

BEFORE OPERATING

SAFETY INSTRUCTIONS

 Do not wear loose fitting clothing as it may catch in moving parts.

 Make sure all guards and shields are installed, including the tractor power take-off (PTO) master shield, before starting or operating the Blower.

 Be sure that the correct implement driveline parts are used and that they are properly secured.

Lower the lifter wheels when the Blower is not in use.

Install safety chain when attaching the Blower to the tractor.

 Clear the area of bystanders, especially children, when making repairs, adjustments, or performing maintenance on the Blower.

 Do not allow riders.



Put all tractor and machine controls in “neutral” and disengage the PTO before starting. Follow the starting instructions according to the OEM tractor manual.

 Operate the Blower only while seated on the tractor seat.

 Make sure the unit is adequately supported with safety blocks or safety stands when changing tires or performing maintenance.

DURING OPERATION

CAUTION

  **Entanglement Hazard**
Keep hands, feet, hair, and clothing away from moving parts. Wait for all movement to stop before approaching equipment. Before making adjustments:

1. Shut off the tractor,
2. Set parking brake,
3. Put machine in neutral, and
4. Remove key while making adjustments.

 Keep all shields and guards in place and in good working condition.

 Keep all bystanders, especially children, away from the Blower while in operation.

 Do not allow riders while the Blower is in operation.

 Do not attempt to unclog, clean, or adjust the Blower while it is running.

 Stay away from overhead power lines. Electrocutation can occur even without direct contact.



 Keep all hydraulic lines, fittings, and couplers tight and free of leaks. (Refer to Safety Guidelines – Hydraulic Safety).

 Use caution when ascending or descending on the Blower. Wet shoes or boots are slippery.

MAINTENANCE SAFETY



SAFETY INSTRUCTIONS

Follow all operating, maintenance, and safety instructions found in this Manual.

   Before servicing, adjusting, repairing, or unclogging the machine, always make sure the tractor engine is stopped, key in your pocket, the machine is lowered to the ground, all controls are placed in neutral, the parking brake is set, and all the moving parts have stopped.

 Use sufficient tools, jacks, and hoists that have the capacity for the job.

 Use support blocks or safety stands when changing tires or performing maintenance.

  Follow good shop practices of keeping the service area clean and dry, and use adequate light for the job at hand.

 Before applying pressure to the hydraulic system, make sure all lines, fittings, and couplers are tightly secured and in good condition.

 Make sure all shields/guards are in place and properly secured when performing maintenance.

HYDRAULIC SAFETY

**SAFETY
INSTRUCTIONS**

Follow all operating, maintenance, and safety instructions found in this Manual.

Make sure components in the hydraulic system are kept clean and in good working condition.



Relieve pressure from the hydraulic system before servicing or disconnecting from the tractor.



Keep all hydraulic lines, fittings, and couplers tightly secured and free of leaks.



Replace any worn, cut, abraded, flattened, or crimped hoses.



Do not make any temporary repairs to the hydraulic lines, fittings, or hoses using tape, clamps, or cement. The hydraulic system operates under extremely high pressure and temporary repairs may fail suddenly and create a hazardous/dangerous situation.



Wear proper hand and eye protection when searching for a high-pressure hydraulic leak. Use a piece of wood or cardboard as a backstop instead of hands to identify and isolate a leak. If injured by a concentrated high-pressure stream of hydraulic fluid, seek medical attention immediately. Serious infection or toxic reaction can develop if hydraulic fluid penetrates the surface of the skin.



Before applying pressure to the system, make sure all components are tight and that the hydraulic lines, hoses, and couplings are not damaged.

TRANSPORTATION SAFETY

**SAFETY
INSTRUCTIONS**

Follow all operating and safety instructions found in this manual when transporting this equipment.

Make sure the Blower complies with all local regulations regarding transporting equipment on public roads and highways.



Make sure the Slow Moving Vehicle (SMV) emblem and all lights and reflectors required by local highway and transportation authorities are properly in place, clean, and clearly visible to traffic.



Do not allow riders on any machinery during transport.

Make sure the Blower is securely attached to the tractor and install a safety chain to the Blower.

Make sure the tractor brake pedals are latched together.

Do not exceed 20 mph (32 km/h) when transporting the Blower. Always reduce speed on rough roads and surfaces, or when going down inclines.

Use caution when turning and always use the turn signals on the tractor to indicate your turning intentions to the other traffic.

The weight of the trailed machine should NEVER exceed the weight of the towing vehicle.

Check all clearances carefully whenever the machine is towed.

Lower the elevator into the transport position before transporting the Blower on the highway.



Stay away from overhead obstructions and power lines during transport. Electrocution can occur even without direct contact.

STORAGE SAFETY

**SAFETY
INSTRUCTIONS**

Follow all operating and safety instructions found in this manual when storing this equipment.



Store the Blower in an area away from human activity.



Do not permit children to play on or around the stored machine at any time.

Make sure that the Blower is stored in an area with a firm and level base to prevent the machine from tipping or sinking into the ground.



Block the wheels to prevent the machine from rolling.

TIRE SAFETY**SAFETY
INSTRUCTIONS**

Follow all operating and safety instructions found in this manual when working around tires.

Have only a qualified tire dealer or tire repair service perform tire repairs.

Do not attempt to install a tire on a wheel or rim unless you have the proper equipment and experience to do the job.

Do not substitute tires with a lesser road rating and/or capacity for the original equipment tires.

WARNING

Explosive Force Hazard
Tire replacement, repair, and/or maintenance should be done by a qualified tire dealer or qualified repair service.

Failure to follow proper procedures when installing a tire on a wheel or rim can produce an explosive force that will result in serious injury or death.

Do not attempt to install a tire without proper equipment and experience to perform the job.

ASSEMBLY SAFETY**SAFETY
INSTRUCTIONS**

Follow all assembly, operating, and safety instructions found in this manual when assembly this equipment.



Use adequate manpower to perform assembly procedures safely.

Assemble the Blower in an area with sufficient space to maneuver the largest components and allow easy access to all sides of the machine.



Use only forklifts, lift cranes, jacks, and tools with sufficient capacity for the loads.



Do not allow spectators, especially children, in the working area.

**THIS PAGE
LEFT
INTENTIONALLY
BLANK**

OPERATOR'S INSTRUCTIONS: SNOW BLOWER

SAFETY PRECAUTIONS

1. Be sure all exposed moving parts such as shafts and adapters are properly guarded and that all coupling devices are securely attached before applying power. Do not use unless all shields are in place.

2. Do not wear loose fitting clothing in the vicinity of any moving parts.

3. Do not exceed recommended ground speed, recommended PTO speed, or recommended horsepower for the unit which you are using.

4. Keep all persons, pets, and livestock away from unit when in use.

5. Do not turn discharge chute towards persons, pets, livestock, or buildings when blower is in operation.

6. Before working on, servicing, or making adjustments to equipment, disengage power, lower unit to ground level, shut off engine, make sure all moving parts have stopped and all pressure in the hydraulic system is relieved.

7. Do not attempt to remove any obstruction from discharge chute until PTO is disengaged and engine is shut off.

8. Do not stand on auger to service any part of blower, as auger may turn causing either, a serious fall; or, the blower fan to rotate, presenting a danger to fingers, hands, or arms in the chute assembly or blower housing.

9. Keep hands and arms away from cables and turner bar of hydraulic hood turner until engine is shut off.

10. Always look to the rear before backing up.

11. Be aware of the presence of people and objects that may be obscured from vision by blowing or drifted snow. Be certain that no children have tunneled into snowbanks which are to be removed. Never let children slide down snowbanks in the vicinity of an operating blower.



Color: Red
Location: Blower Side

Stones or other objects may be thrown great distances by the auger, especially at higher RPMs. Do not stand in front of the blower when it is in operation.

Any debris or stones which are swept into the fan can be thrown great distances. Do not allow any bystanders

to stand in the path of the discharge chute.

Shields are supplied for your protection. Do not remove shields and do not operate the machine unless all shields are in place.

Do not service, adjust, or repair, until the PTO has been disengaged, the motor shut off, the unit lowered to the ground, and all parts have stopped moving. Any moving part has the possibility of entangling the operator or his clothing, and causing serious injury, dismemberment, or death.



Color: Red
Location: PTO Shaft

Never go near any moving parts. Because tractor PTO's may be accidentally engaged, never attempt to lubricate, repair or couple PTO unless tractor engine is shut off. Do not remove shields. Be sure that PTO shield turns freely and independently of the driveline. Do not operate

unless all shields are in place. Be sure that PTO shaft is attached securely at both ends before operating.

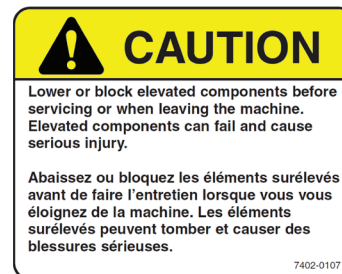

Color: Yellow
Location: Blower Back

Do not service, adjust or repair any equipment attached to the three-point hitch hydraulics, without lowering the unit to the ground. If work must be performed underneath the unit, block the unit in a raised position.



Color: Orange
Location: Blower Back

Do not attempt any servicing of the blower while the tractor engine is running. If the tractor PTO is accidentally engaged the serviceman could become entangled in moving parts and be seriously injured or killed. Be certain. Be safe. Shut off the engine.



Color: Yellow
Location: Blower Back

Every effort is made to ensure that a well constructed high quality product leaves the manufacturer. Again the dealer inspects and services each unit before it leaves his lot.

To keep your blower in good operating condition, please inspect and retighten as necessary any loose nuts or studs after a half hour break in period. Thereafter periodic checks will ensure that your blower remains in top working condition.

PRE-SALE SERVICE, SETUP, OPERATION, & POST-SALE SERVICE**PRE-SALE SERVICE & SETUP OF BLOWERS**

1. Turn hood to point directly behind blower. (PTO side)
2. Lift hood assembly off and spread a light coat of grease on outside of blower mainframe pipe.
3. Replace hood assembly.
4. Install hood turner as per instructions.
5. Grease shear assembly, auger bearings, and hydraulic hood turner if installed.
6. Check oil level in gearbox.
7. Check all bolts for tightness.
8. Check auger drive chain tension and alignment. Adjust if necessary.
9. Grease PTO universal joints, shield retaining collars, and inner tube of PTO.

OPERATION

1. When attaching the blower make certain all guards are in place.
2. Ensure that the fan and auger rotate freely before connecting PTO shaft to the tractor.
3. Use proper pins and ensure that all connections are secure.
4. Engage the PTO at low engine RPM and slowly increase speed to operating level. Operating speed will vary with snow, weather, and ground conditions.
5. Adjust the top link of the three-point hitch to match the ground and snow conditions. Increasing the length will cause the blower to cut deeper into compacted snow, but may also cause the blower to scrape gravel or stones into the fan, which can be a danger to nearby persons, pets, livestock or buildings. Decreasing the length of the top link causes the blower to ride back on the skid shoes, raising the cut-

ting height, thereby reducing the possibility of scraping gravel or stones into the blower.

6. Adjust the deflector for the distance of throw required. Moving the adjusting bar, to shorten the distance between the pins increases the distance thrown.

7. Be aware of the presence of people and objects that may be obscured from vision by blowing or drifted snow. Be certain that no children have tunneled into snowbanks which are to be removed. Never let children slide down snowbanks in the vicinity of an operating blower.

SERVICE

1. Before servicing or adjusting, disengage the PTO, lower the unit to the ground, and shut off engine.
2. To prevent freezing of hood or other moving parts apply a solution of antifreeze or light oil.
3. Check gearbox oil level on a regular basis. If oil level is low, use a good quality 80W-90 gear oil. Change oil after 50 hours during break-in period. Change after 700 - 750 hours or yearly. Capacity: Compact - .35 litres; Standard - .6 litres; Farm Utility - 1.3 litres; Heavy Duty - 2.5 litres.
4. Grease the shear assembly and hydraulic hood turner every five hours of operation.
5. Grease the auger bearings every ten hours of operation.
6. Follow the chart on the PTO shaft for recommended lubrication intervals on PTO.
7. Check auger drive chain tension and alignment. Adjust if necessary.

INSTALLATION INSTRUCTIONS

A proper initial installation will give you years of satisfactory service on your equipment. Please read carefully following instructions which have been specially made to help you and make you satisfied with your purchase.

WARNING:

Unfortunately, snowblowers will be faced with forgotten or hidden objects under the snow, such as: chain, tires, stones, pieces of wood, etc.... In spite of all our efforts, machines are not built to resist all those conditions.

DANGER: TOO BIG TRACTOR

It is dangerous to use a tractor which is too big or too powerful. The tractor will always be able to overload the blower, even if the machine is already at maximum capacity. Tractor being very high, too large angles at P.T.O. universal joints will result, and life of universal joints will be shortened dramatically.

P.T.O. SHAFT ANGLES

P.T.O. shafts are made to transmit power with angles at universal joints. However, these angles should be kept to a minimum. Larger the angle, shorter the life of P.T.O. Take for example a snowblower sold for a tractor capacity of 60-70 H.P., which would be attached to a 60 H.P. tractor, operating at maximum capacity (60 H.P. continuous).

H.P.	P.T.O. angles	Estimated life in hours
60 @ 540 RPM	5°	450 hours
Using #50 PTO	10°	195 hours
	15°	90 hours
	20°	40 hours
	25°	20 hours

HOW TO DETERMINE P.T.O. ANGLE

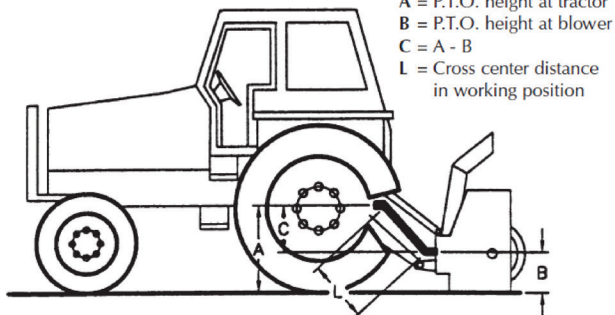

- 1) Lower blower on ground.
- 2) Take measures A, B and L
- 3) Subtract B of A (A - B = C)
- 4) Divide L by C (L ÷ C = F)
- 5) Compare F Factor in table to find P.T.O. angle (interpolate, if necessary).

F FACTOR	ANGLE
6	10°
3.75	15°
2.75	20°
2.15	25°
1.75	30°

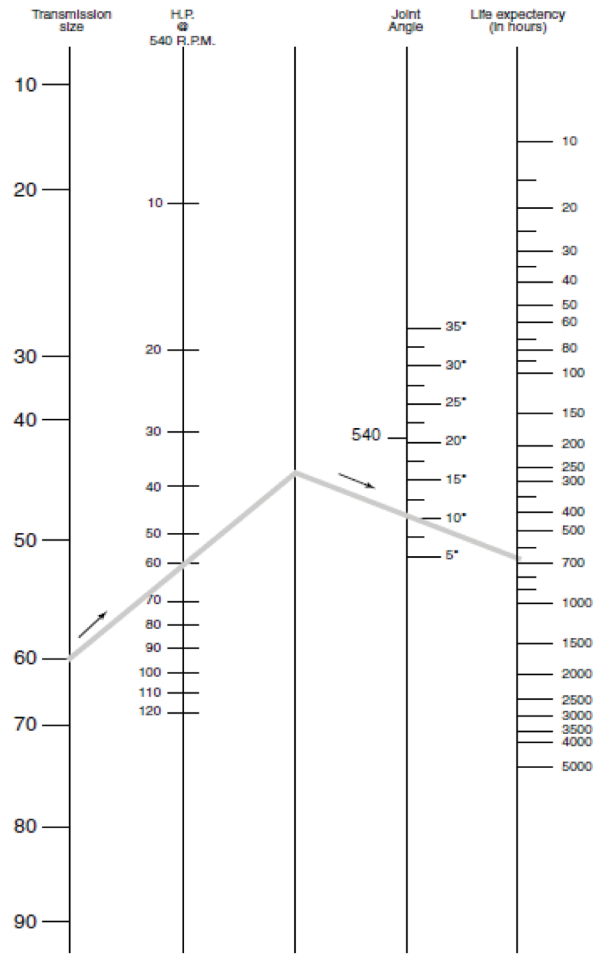

This table is valid only for 540 R.P.M.

Previous examples clearly demonstrate that universal joint angle is directly related with life of P.T.O. In order to reduce angle, it is necessary to increase the distance between snowblower and tractor

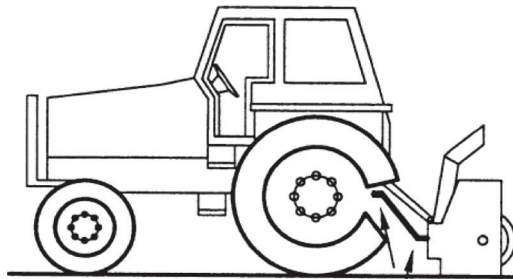

AVOID
Too Large Angles at P.T.O Joints

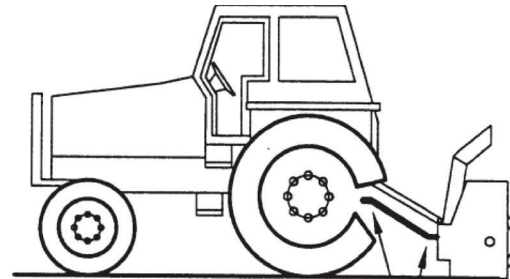

ACCEPTABLE
Reasonable Angles at P.T.O Joints

INSTALLATION INSTRUCTIONS

If it is impossible to increase the distance between snowblower and tractor, in order to maintain a reasonable angle at P.T.O., it is recommended to use a larger size of P.T.O., that is a greater capacity P.T.O. (please refer to your dealer for more details).

For snowblowers of 100 H.P., an additional gearbox is also available that can be mounted on existing snowblower gearbox, which increased the input shaft height, reducing angle at P.T.O. joints. This gearbox also has an input speed of 1000 R.P.M., which greatly increases P.T.O. capacity.

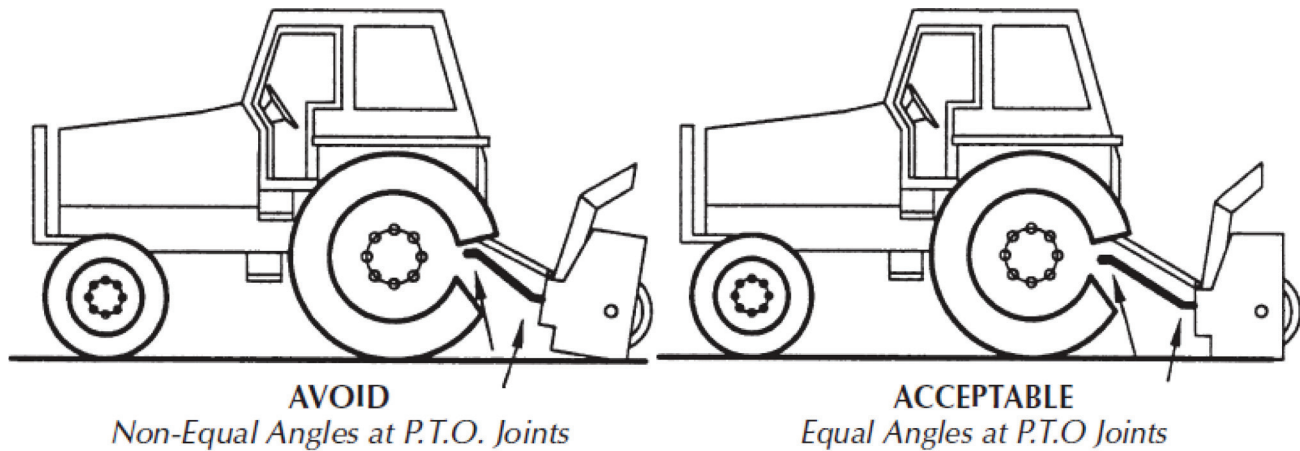

ANGLES AT EACH END OF P.T.O.

A popular habit is to change snowblower angle in order to obtain a better scraping effect. This practice can become harmful to the P.T.O., angle at each end being unequal. There will be a fan speed variation as well as a drastic increase of load on cross and bearings. To Avoid. It is recommended to keep tractor P.T.O. shaft and snowblower input shaft always parallel.

SHEAR BOLTS

Shear bolts are built to break under shocks on the fan or on the auger. However, under certain circumstances, this security is not adequate. Example: A sudden high impact shock on the fan may, in some cases, break the fan shaft without breaking the shear bolt. If the shear bolt breaks, make sure to always replace it with a same category bolt (grade 8.8). It is necessary to always maintain this bolt very tight, in order to keep the efficiency of the shearing mechanism.

WARNING:

The gearbox fan shafts are made with special alloy steel. Moreover, they are case hardened to increase capacity to shock load. These shafts cannot be broken under normal snow loads. However, undesirable objects may enter the fan and either bend or break gearbox shaft. It is understood that gearbox cannot be built to resist every possible overloads, and consequently, gearbox fan shafts will not be replaced under warranty. Therefore, the user of the snowblower must be very careful.

MAXIMUM LENGTH OF P.T.O. SHAFT

WARNING:

Telescopic tubes of P.T.O. should overlap a minimum length to meet ideal conditions for power transmission.

NOTE: The Following table could be used as a guide to find the maximum permissible length of P.T.O.:

P.T.O.	OVERALL LENGTH		TELESCOPIC TUBES OVERLAP
	CLOSED	OPENED MAX	
T20-056P	29:3/4"	41"	5"
T40-056P	30:1/2"	40:1/2"	6"
T50-071P	36:1/2"	50"	7"
T60-071P	37:3/4"	51:1/4"	7"
T80-066P	36"	47:1/4"	7"
T80-076P	40:1/2"	53"	8"
T90-071P	39"	51"	8"

**THIS PAGE
LEFT
INTENTIONALLY
BLANK**

ILLUSTRATED PARTS LIST: SNOW BLOWER

BLOWER ASSEMBLY

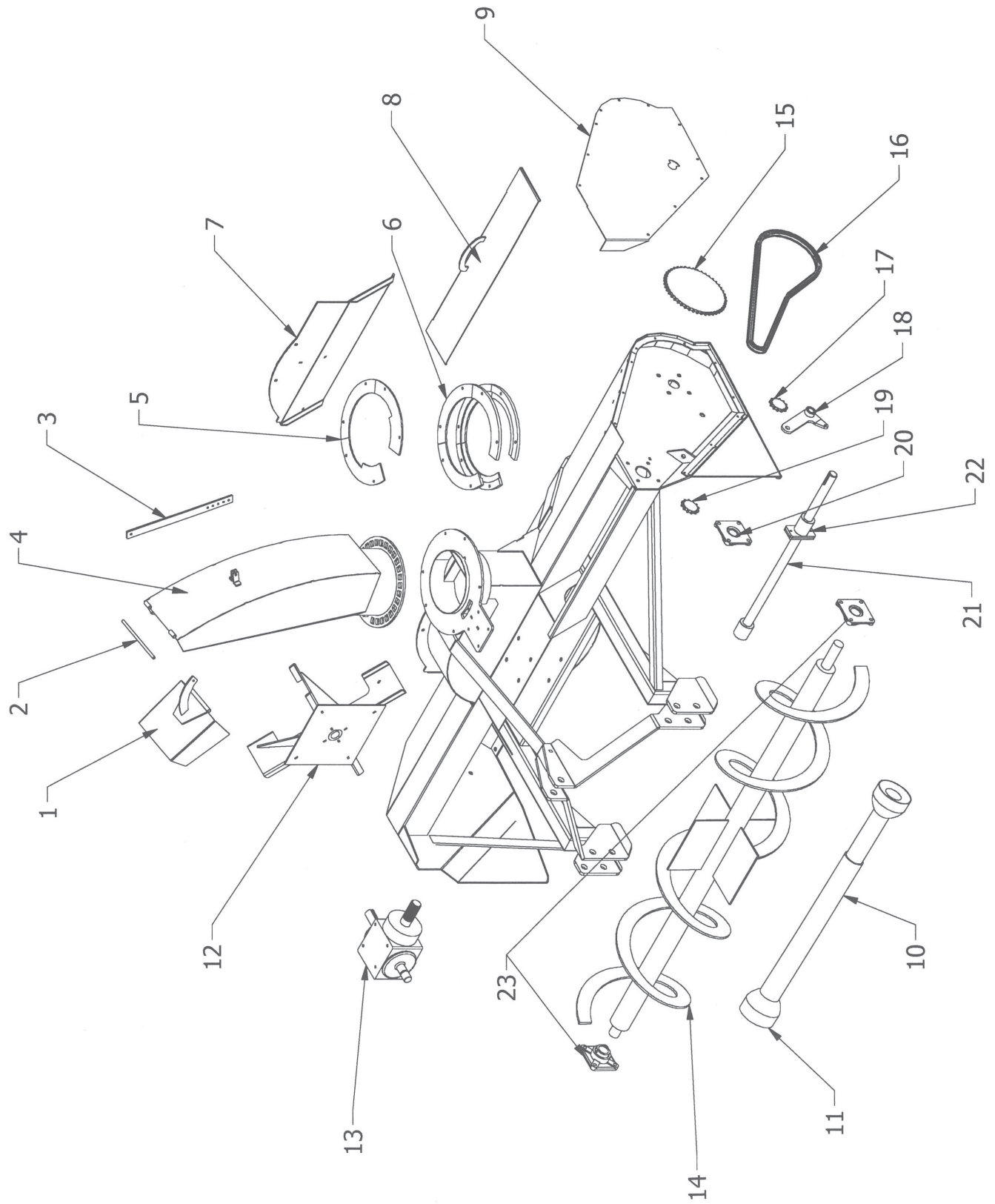

ITEM	DESCRIPTION	MODEL	
		7384	7396
1	SNOW CHUTE	4020-31	4020-31
2	CHUTE PIN	4020-33	4020-33
3	CHUTE ADJ FLAT BAR	4020-32	4020-32
4	HOOD	4020-30	4020-30
5	HOOD MOUNT RING	4020-34	4020-34
6	HOOD ROTATION UHMW STRIPS	4020-35	4020-35
7	FAN COVER	4130-73	4130-74
8	CROSS SHAFT COVER	4130-53	4130-54
9	DRIVELINE COVER	4130-63	4130-63
10	PTO SHAFT	5401.0203	5401.0211
11	PTO SHAFT PIN	5450.000511	5450.000507
12	FAN	4015-30	4015-40
13	GEAR BOX	5401.0103	5401.0103
14	AUGER	4105-21	4105-22
15	AUGER DRIVE SPROCKET LARGE	5401.0606	5401.0606
16	AUGER DRIVE CHAIN	5420-03	01-75
17	CHAIN TENTIONER SPROCKET	5401.0402	5401.0403
18	CHAIN TENTIONER PIVOT ARM	4140-30	4140-30
19	AUGER DRIVE SPROCKET SMALL	5401-0609	5401-0609
20	CROSS SHAFT BEARING	5415-0224	5414-0224
21	CROSS SHAFT	4110-20	4110-30
22	CROSS SHAFT SHEAR BOLTS	5450.00043	5450.00043
23	AUGER BEARING	5415.0209	5415.0209

HOOD TURNER ASSEMBLY

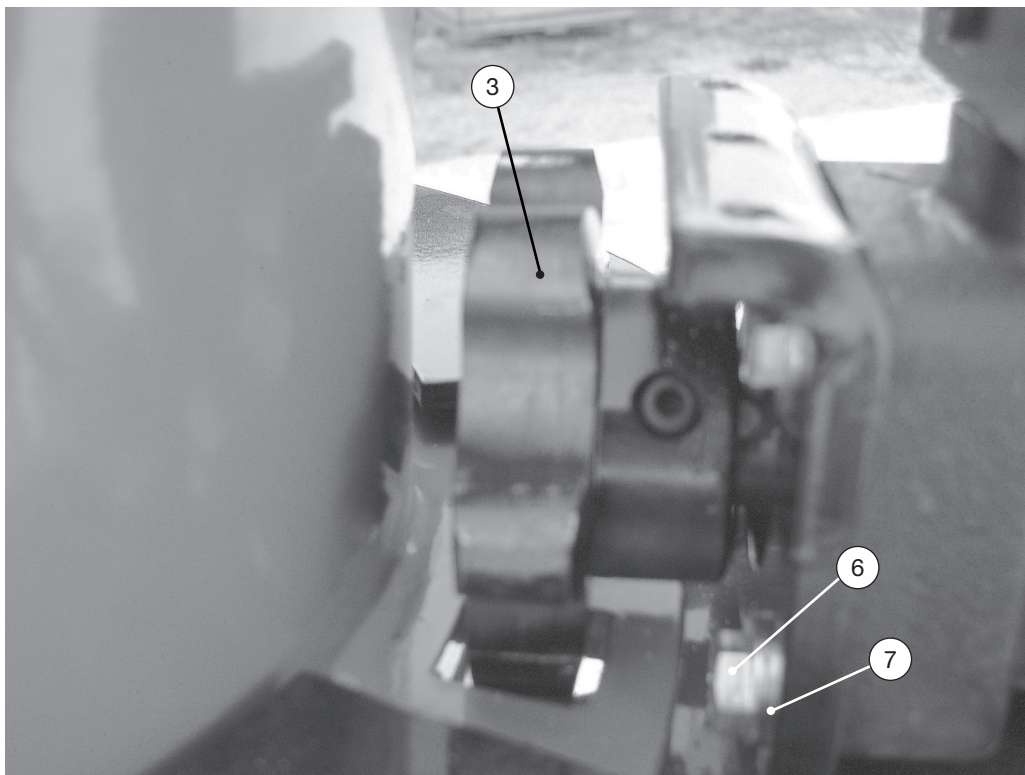
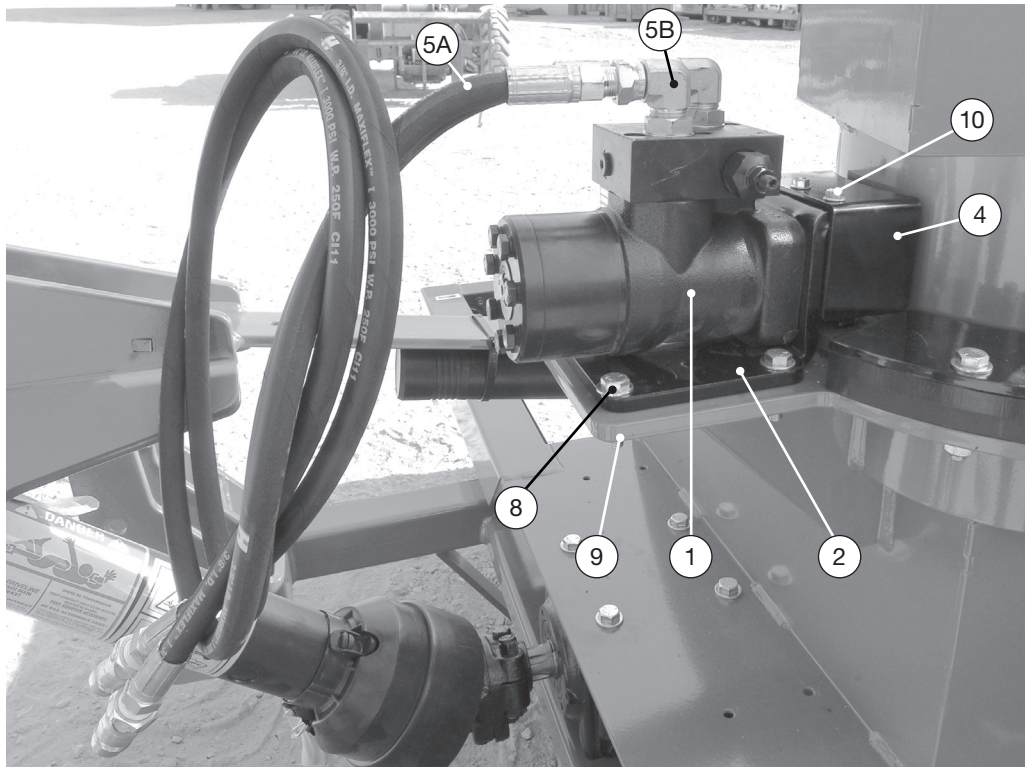

ITEM	PART NUMBER	DESCRIPTION	COMP
1	5401 - 1060	HYD. MOTOR	1
2	4035-20	HYD./ORBITAL TURNER BRKT.	1
3	5401 - 1057	SPROCKET	1
4	4035-60	SHIELD FOR HYD. TURNER	1
5A	7522 - 0060	HOSE	2
5B	7520 - 9515	FITTING	2
6	7001 - 0312	3/8 X 1 BOLT GD.5 PLATED	4
7	7001 - 0305	3/8 LOCKWASHER PLATED	4
8	7001 - 0313	3/8 X 1-1/4 BOLT GD.5 PLATED	3
9	7001 - 0302	3/8 X LOCK NUT NYLON PLATED	3
10	7001 - 1205	#12 X 1/2 SELF TAP SCREW	3

PROCEDURE TO MOUNT THE HYDRAULIC TURNER

1. Place the orbital motor (5401-1060) through the bracket (4035-20) so that the shaft of the motor is towards the gusset of the bracket and the ports are upward. Bolt in place using a 3/8 x 1 bolts and 3/8 lock washers
2. Put sprocket on shaft with hub towards motor.
3. Now position the bracket to bolt it to the turner mounting plate and bolt in place using 3/8 x 1 1/4 bolts and 3/8 lock nuts.
4. Now set the sprocket so that it is in the centre of the holes, looking from the closest edge to the hood and the farthest edge from the hood. Tighten the set screws on the sprocket
5. Now take the hydraulic fittings and hoses and attach them to the orbital motor. Place the shield on the top of the bracket and attach it using the self tap screws.

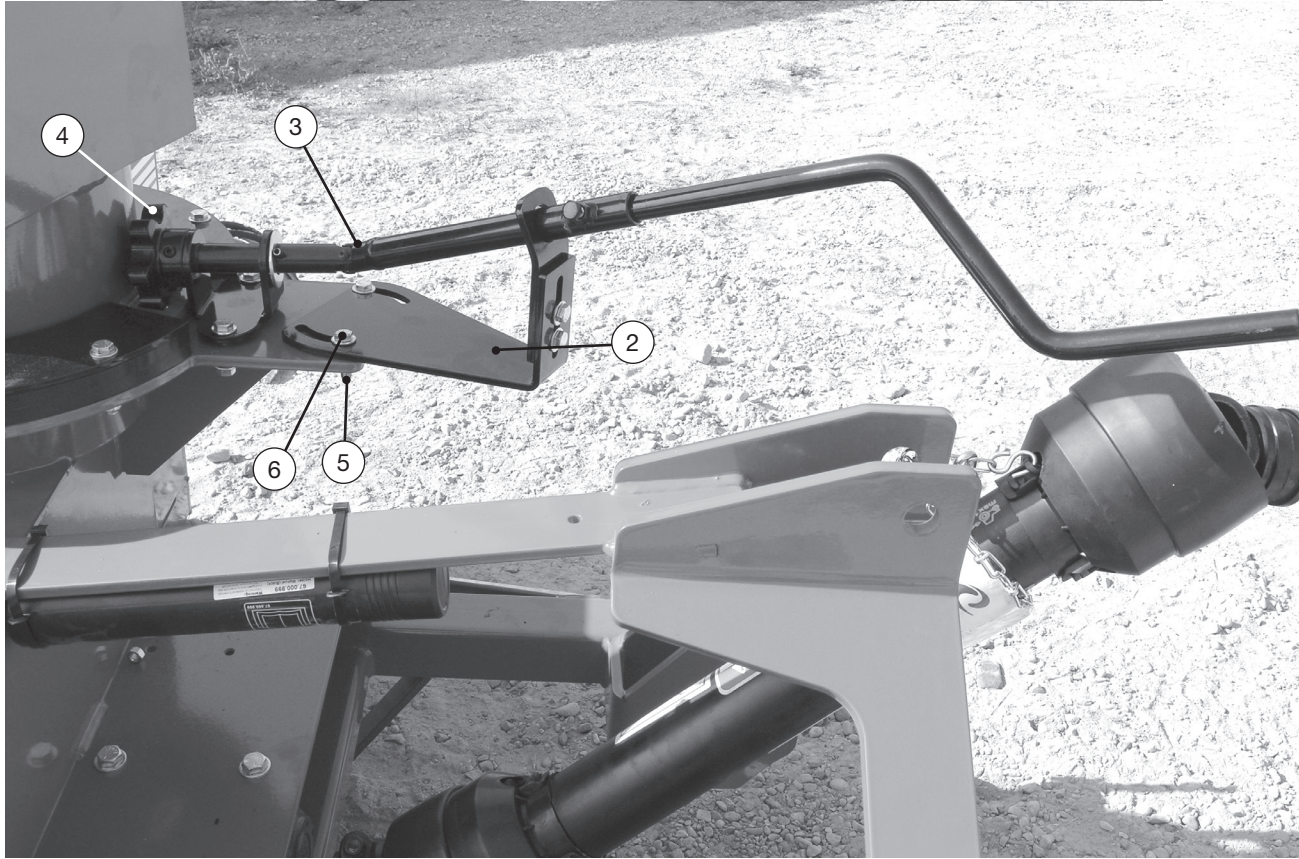
HYDRAULIC TURNER ASSEMBLY

ITEM	PART NUMBER	DESCRIPTION	MODEL				
			COMP	STD	FUS	FUD	HD
1	4030 - 14	HAND CRANK / COMP. & STD.	1	1	-	-	-
1	4030 - 12	HAND CRANK	-	-	1	-	-
2	4030-25	MAN. HOOD TURNER CRANK SUPPORT	1	1	1	-	-
3	4030-20	MAN. HOOD TURNER	1	1	1	-	-
4	5401 - 1057	SPROCKET	1	1	1	-	-
5	7001 - 0302	3/8 LOCK NUT NYLON PLATED	2	2	2	-	-
6	7001 - 0313	3/8 X 1-1/4 BOLT GD.5 PLATED	2	2	2	-	-

PROCEDURE TO MOUNT MANUAL TURNER

1. Place the crank assembly into tubing of the other part of the turner (4030-20), starting at the end opposite the sprocket.
2. Tighten the 3/8 X 1 bolt to hold the crank tight in the tube.
3. Place the sprocket onto the gear on the hood and bolt the feet down, to the turner mounting plate.
4. Check to ensure that the 1/4 X 2 flat bars are still perpendicular to the crank and tube of the turner.
5. With the unit attached to the tractor, check to ensure that the crank is at the desired extension as well as ensuring clearance to the tractor and operator in the full range of movement of the three point hitch.

P.T.O. ASSEMBLY (EG SHAFTS)

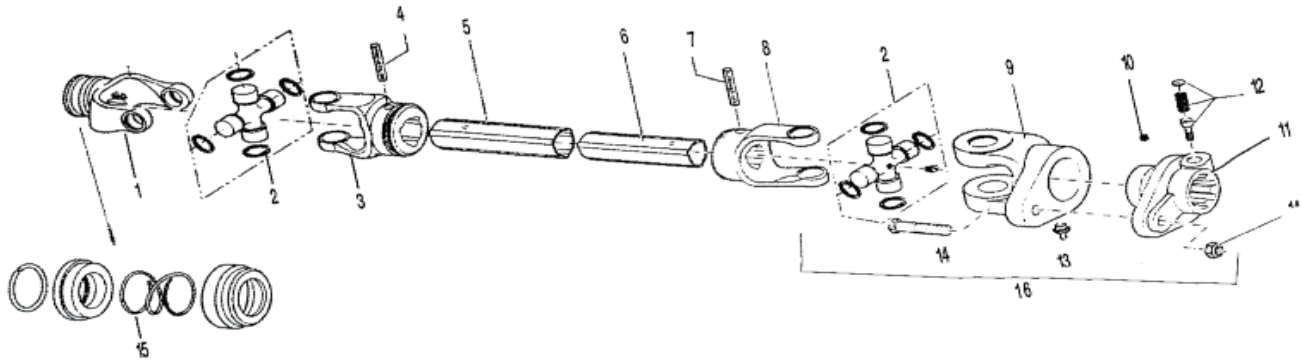

ITEM #	DESCRIPTION	SHAFT SIZE				
		20	40	50	60	80
1	YOKE 1-3/8 Z.6 PUSH PIN	022001	024001	025001	026001	028001
1A	YOKE 1-3/8 Z.6 LOCK COLLAR	022324	024430	025363	026544	028423
1B	YOKE 1-3/4 Z.20 PUSH PIN	-	-	-	026008	028004
1C	YOKE 1-3/4 Z.20 LOCK COLLAR	-	-	-	026555	028428
1D	YOKE 1 RB 1/4 KEY	012058	-	-	-	-
2	CROSS JOURNAL	012130	014130	015130	016130	018130
3	YOKE OUTER TUBE	012003	014006	015011	160028	018009
4	ROLL PIN OUTER TUBE	000012	000014	000016	000018	000343
5	OUTER TUBE	120200	130200	150200	160215	160200
6	INNER TUBE	120100	140100	150100	160115	170100
7	ROLL PIN INNER TUBE	000011	000012	000394	000016	000271
8	YOKE INNER TUBE	012002	014007	015012	016029	018008
9	SHEAR YOKE	012005	014012	015024	016042	018023
10	BALL	000024	000022	000022	000023	000023
11	HUB 1-3/8 Z.6	022010	024013	025027	026043	028024
11A	HUB 1-3/8 Z.6	-	-	-	-	028037
11B	HUB 1-3/4 Z.20	-	-	-	-	028038
12	PUSH PIN SET 1-3/8	026004	026004	026004	026004	026004
12A	PUSH PIN SET 1-3/4	-	-	-	026005	026005
12B	INTERFERING BOLT	000525	000525	000525	000525	-
13	GREASE FITTING	000020	000020	000020	000021	000021
14	SHEAR BOLT	000509	000505	000511	000507	000512
15	COLLAR KIT 1-3/8	000628	000628	000628	000628	000628
15A	COLLAR KIT 1-3/4	-	-	-	000629	000629
16	SHEAR ASSY. 1-3/8 Z6	220001	24001	250016	260006	280001
16A	SHEAR ASSY. 1-3/4 Z20	-	-	-	-	280004

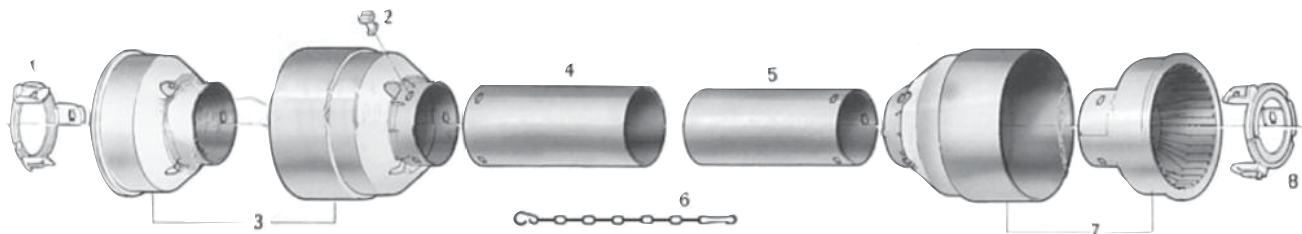

SHAFT SIZE	PART NUMBER
20	220214
40	240214
50	250214
60	260214
80	286049

NOTE:
Shields available as complete only. Parts shown for assembly purposes.

100 series blowers use shaft size 20. 2000 series blowers use shaft size 40. 3000 series blowers use shaft size 50 for 78 & 84, shaft size 60 for 90 & 96. 4000 series blowers use shaft size 80.

NOTE: When ordering add the suffix "5450" before the order numbers (ie: Roll Pin Shaft Size 10 - 5450-000010)



Metco Inc. TECHNICAL MANUALS

Manuals are available from your local dealer or Metco Inc. for the operation, service, and repair of your machine. For prompt convenient service, contact your local dealer for assistance in obtaining the manuals for your machine.

Your local dealer can expedite your order for operator manuals, illustrated parts catalogs, service manuals, and maintenance records.

Always give the Machine Name, Model, and Serial Number so your local dealer can provide the correct manuals for your machine

Metco Inc. reserves the right to make improvements in design or changes in specifications at any time without incurring any obligation to install them on units previously sold.

Except as expressly authorized, no part of this manual may be reproduced, copied, transmitted, disseminated, downloaded or stored in any storage medium, for any purpose without the express prior written consent of Metco Inc.

METCO INC.
1005 Tribe Road
West Montrose, ON, Canada
N0B 2V0